

HUCK-FIT

UNINSTALLED PINS

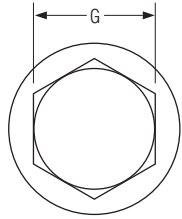

FLANGED HEX

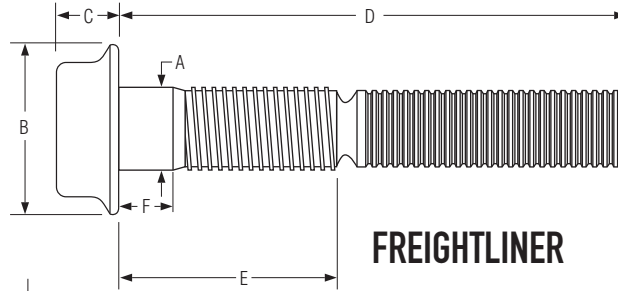
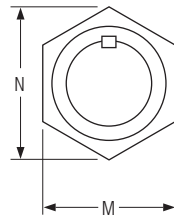
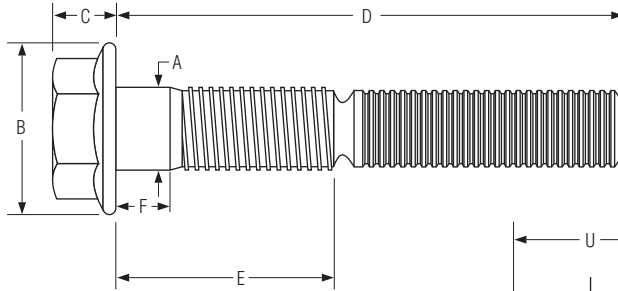
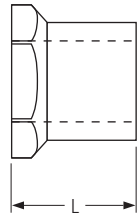

FREIGHTLINER

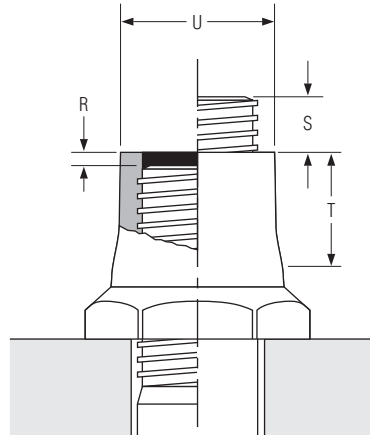

INSTALLED FASTENER

HUCK® INTERACTIVE CD ROM : DIMENSIONS

HUCK-FIT

Family	Headstyle	Material	Diameter	Grip	Part Number	Nom Dia mm	Min Hole Size mm	Max Hole Size mm	Max B mm	Max C mm	Nominal G mm	Max E mm	Max D mm	Nominal F mm	MHCH Min Grip mm	MHCH Max Grip mm
MHF	F	DT	12	10	MHFF-DT12-10	12.0	12.0	13.5	24.8	11.9	15.0	39.3	92.6	4.2	5.0	15.0
MHF	F	DT	12	15	MHFF-DT12-15	12.0	12.0	13.5	24.8	11.9	15.0	44.3	97.6	9.2	10.0	20.0
MHF	F	DT	12	20	MHFF-DT12-20	12.0	12.0	13.5	24.8	11.9	15.0	49.3	102.6	14.2	15.0	25.0
MHF	F	DT	12	25	MHFF-DT12-25	12.0	12.0	13.5	24.8	11.9	15.0	54.3	107.6	19.2	20.0	30.0
MHF	F	DT	12	30	MHFF-DT12-30	12.0	12.0	13.5	24.8	11.9	15.0	59.3	112.6	24.2	25.0	35.0
MHF	F	DT	12	35	MHFF-DT12-35	12.0	12.0	13.5	24.8	11.9	15.0	64.3	117.6	29.2	30.0	40.0
MHF	F	DT	12	40	MHFF-DT12-40	12.0	12.0	13.5	24.8	11.9	15.0	69.3	122.6	34.2	35.0	45.0
MHF	F	DT	12	45	MHFF-DT12-45	12.0	12.0	13.5	24.8	11.9	15.0	74.3	127.6	39.2	40.0	50.0
MHF	F	DT	12	50	MHFF-DT12-50	12.0	12.0	13.5	24.8	11.9	15.0	79.3	132.6	44.2	45.0	55.0
MHF	F	DT	12	55	MHFF-DT12-55	12.0	12.0	13.5	24.8	11.9	15.0	84.3	137.6	49.2	50.0	60.0
MHF	F	DT	12	60	MHFF-DT12-60	12.0	12.0	13.5	24.8	11.9	15.0	89.3	142.6	54.2	55.0	65.0
MHF	F	DT	12	65	MHFF-DT12-65	12.0	12.0	13.5	24.8	11.9	15.0	94.3	147.6	59.2	60.0	70.0
MHF	F	DT	12	70	MHFF-DT12-70	12.0	12.0	13.5	24.8	11.9	15.0	99.3	152.6	64.2	65.0	75.0
MHF	F	DT	12	75	MHFF-DT12-75	12.0	12.0	13.5	24.8	11.9	15.0	104.3	157.6	69.2	70.0	80.0
MHF	F	DT	16	10	MHFF-DT16-10	16.0	16.0	17.5	32.9	15.1	20.8	45.7	105.2	3.8	5.0	15.0
MHF	F	DT	16	15	MHFF-DT16-15	16.0	16.0	17.5	32.9	15.1	20.8	50.7	110.2	8.8	10.0	20.0
MHF	F	DT	16	20	MHFF-DT16-20	16.0	16.0	17.5	32.9	15.1	20.8	55.7	115.2	13.8	15.0	25.0
MHF	F	DT	16	25	MHFF-DT16-25	16.0	16.0	17.5	32.9	15.1	20.8	60.7	120.2	18.8	20.0	30.0
MHF	F	DT	16	30	MHFF-DT16-30	16.0	16.0	17.5	32.9	15.1	20.8	65.7	125.2	23.8	25.0	35.0
MHF	F	DT	16	35	MHFF-DT16-35	16.0	16.0	17.5	32.9	15.1	20.8	70.7	130.2	28.8	30.0	40.0
MHF	F	DT	16	40	MHFF-DT16-40	16.0	16.0	17.5	32.9	15.1	20.8	75.7	135.2	33.8	35.0	45.0
MHF	F	DT	16	45	MHFF-DT16-45	16.0	16.0	17.5	32.9	15.1	20.8	80.7	140.2	38.8	40.0	50.0
MHF	F	DT	16	50	MHFF-DT16-50	16.0	16.0	17.5	32.9	15.1	20.8	85.7	145.2	43.8	45.0	55.0
MHF	F	DT	16	55	MHFF-DT16-55	16.0	16.0	17.5	32.9	15.1	20.8	90.7	150.2	48.8	50.0	60.0
MHF	F	DT	16	60	MHFF-DT16-60	16.0	16.0	17.5	32.9	15.1	20.8	95.7	155.2	53.8	55.0	65.0
MHF	F	DT	16	65	MHFF-DT16-65	16.0	16.0	17.5	32.9	15.1	20.8	100.7	160.2	58.8	60.0	70.0
MHF	F	DT	16	70	MHFF-DT16-70	16.0	16.0	17.5	32.9	15.1	20.8	105.7	165.2	63.8	65.0	75.0
MHF	F	DT	16	75	MHFF-DT16-75	16.0	16.0	17.5	32.9	15.1	20.8	110.7	170.2	68.8	70.0	80.0
MHF	F	DT	16	80	MHFF-DT16-80	16.0	16.0	17.5	32.9	15.1	20.8	115.7	175.2	73.8	75.0	85.0
MHF	F	DT	16	85	MHFF-DT16-85	16.0	16.0	17.5	32.9	15.1	20.8	120.7	180.2	78.8	80.0	90.0
MHF	F	DT	16	90	MHFF-DT16-90	16.0	16.0	17.5	32.9	15.1	20.8	125.7	185.2	83.8	85.0	95.0
MHF	F	DT	20	10	MHFF-DT20-10	20.0	20.0	22.0	43.1	17.8	29.6	51.6	121.5	3.7	5.0	15.0
MHF	F	DT	20	15	MHFF-DT20-15	20.0	20.0	22.0	43.1	17.8	29.6	56.6	126.5	8.7	10.0	20.0
MHF	F	DT	20	20	MHFF-DT20-20	20.0	20.0	22.0	43.1	17.8	29.6	61.6	131.5	13.7	15.0	25.0
MHF	F	DT	20	25	MHFF-DT20-25	20.0	20.0	22.0	43.1	17.8	29.6	66.6	136.5	18.7	20.0	30.0
MHF	F	DT	20	30	MHFF-DT20-30	20.0	20.0	22.0	43.1	17.8	29.6	71.6	141.5	23.7	25.0	35.0
MHF	F	DT	20	35	MHFF-DT20-35	20.0	20.0	22.0	43.1	17.8	29.6	76.6	146.5	28.7	30.0	40.0
MHF	F	DT	20	40	MHFF-DT20-40	20.0	20.0	22.0	43.1	17.8	29.6	81.6	151.5	33.7	35.0	45.0
MHF	F	DT	20	45	MHFF-DT20-45	20.0	20.0	22.0	43.1	17.8	29.6	86.6	156.5	38.7	40.0	50.0
MHF	F	DT	20	50	MHFF-DT20-50	20.0	20.0	22.0	43.1	17.8	29.6	91.6	161.5	43.7	45.0	55.0
MHF	F	DT	20	55	MHFF-DT20-55	20.0	20.0	22.0	43.1	17.8	29.6	96.6	166.5	48.7	50.0	60.0
MHF	F	DT	20	60	MHFF-DT20-60	20.0	20.0	22.0	43.1	17.8	29.6	101.6	171.5	53.7	55.0	65.0
MHF	F	DT	20	65	MHFF-DT20-65	20.0	20.0	22.0	43.1	17.8	29.6	106.6	176.5	58.7	60.0	70.0
MHF	F	DT	20	70	MHFF-DT20-70	20.0	20.0	22.0	43.1	17.8	29.6	111.6	181.5	63.7	65.0	75.0
MHF	F	DT	20	75	MHFF-DT20-75	20.0	20.0	22.0	43.1	17.8	29.6	116.6	186.5	68.7	70.0	80.0
MHF	F	DT	20	80	MHFF-DT20-80	20.0	20.0	22.0	43.1	17.8	29.6	121.6	191.5	73.7	75.0	85.0
MHF	F	DT	20	85	MHFF-DT20-85	20.0	20.0	22.0	43.1	17.8	29.6	126.6	196.5	78.7	80.0	90.0
MHF	F	DT	20	90	MHFF-DT20-90	20.0	20.0	22.0	43.1	17.8	29.6	131.6	201.5	83.7	85.0	95.0
MHF	F	DT	20	95	MHFF-DT20-95	20.0	20.0	22.0	43.1	17.8	29.6	136.6	206.5	88.7	90.0	100.0
MHF	P8	DT	14	10	MHFP8-DT14-10	14.0	14.0	15.5	29.8	11.2	15.0	42.6	95.5	3.8	5.0	15.0
MHF	P8	DT	14	15	MHFP8-DT14-15	14.0	14.0	15.5	29.8	11.2	15.0	47.6	100.5	8.8	10.0	20.0

HUCK® INTERACTIVE CD ROM : DIMENSIONS (CONTINUED)

HUCK-FIT

Family	Headstyle	Material	Diameter	Grip	Part Number	Nom Dia mm	Min Hole Size mm	Max Hole Size mm	Max B mm	Max C mm	Nominal G mm	Max E mm	Max D mm	Nominal F mm	MHCH Min Grip mm	MHCH Max Grip mm
MHF	P8	DT	14	20	MHFP8-DT14-20	14.0	14.0	15.5	29.8	11.2	52.6	105.5	13.8	15.0	25.0	
MHF	P8	DT	14	25	MHFP8-DT14-25	14.0	14.0	15.5	29.8	11.2	57.6	110.5	18.8	20.0	30.0	
MHF	P8	DT	14	30	MHFP8-DT14-30	14.0	14.0	15.5	29.8	11.2	62.6	115.5	23.8	25.0	35.0	
MHF	P8	DT	14	35	MHFP8-DT14-35	14.0	14.0	15.5	29.8	11.2	67.6	120.5	28.8	30.0	40.0	
MHF	P8	DT	14	40	MHFP8-DT14-40	14.0	14.0	15.5	29.8	11.2	72.6	125.5	33.8	35.0	45.0	
MHF	P8	DT	14	45	MHFP8-DT14-45	14.0	14.0	15.5	29.8	11.2	77.6	130.5	38.8	40.0	50.0	
MHF	P8	DT	14	50	MHFP8-DT14-50	14.0	14.0	15.5	29.8	11.2	82.6	135.5	43.8	45.0	55.0	
MHF	P8	DT	14	55	MHFP8-DT14-55	14.0	14.0	15.5	29.8	11.2	87.6	140.5	48.8	50.0	60.0	
MHF	P8	DT	14	60	MHFP8-DT14-60	14.0	14.0	15.5	29.8	11.2	92.6	145.5	53.8	55.0	65.0	
MHF	P8	DT	14	65	MHFP8-DT14-65	14.0	14.0	15.5	29.8	11.2	97.6	150.5	58.8	60.0	70.0	
MHF	P8	DT	14	70	MHFP8-DT14-70	14.0	14.0	15.5	29.8	11.2	102.6	155.5	63.8	65.0	75.0	
MHF	P8	DT	14	75	MHFP8-DT14-75	14.0	14.0	15.5	29.8	11.2	107.6	160.5	68.8	70.0	80.0	
MHF	P8	DT	16	10	MHFP8-DT16-10	16.0	Consult Huck	Consult Huck	Consult Huck	Consult Huck	Consult Huck	Consult Huck	Consult Huck	Consult Huck	Consult Huck	Consult Huck
MHF	P8	DT	16	15	MHFP8-DT16-15	16.0	Consult Huck	Consult Huck	Consult Huck	Consult Huck	Consult Huck	Consult Huck	Consult Huck	Consult Huck	Consult Huck	Consult Huck
MHF	P8	DT	16	20	MHFP8-DT16-20	16.0	Consult Huck	Consult Huck	Consult Huck	Consult Huck	Consult Huck	Consult Huck	Consult Huck	Consult Huck	Consult Huck	Consult Huck
MHF	P8	DT	16	25	MHFP8-DT16-25	16.0	Consult Huck	Consult Huck	Consult Huck	Consult Huck	Consult Huck	Consult Huck	Consult Huck	Consult Huck	Consult Huck	Consult Huck
MHF	P8	DT	16	30	MHFP8-DT16-30	16.0	Consult Huck	Consult Huck	Consult Huck	Consult Huck	Consult Huck	Consult Huck	Consult Huck	Consult Huck	Consult Huck	Consult Huck
MHF	P8	DT	16	35	MHFP8-DT16-35	16.0	Consult Huck	Consult Huck	Consult Huck	Consult Huck	Consult Huck	Consult Huck	Consult Huck	Consult Huck	Consult Huck	Consult Huck
MHF	P8	DT	16	40	MHFP8-DT16-40	16.0	Consult Huck	Consult Huck	Consult Huck	Consult Huck	Consult Huck	Consult Huck	Consult Huck	Consult Huck	Consult Huck	Consult Huck
MHF	P8	DT	16	45	MHFP8-DT16-45	16.0	Consult Huck	Consult Huck	Consult Huck	Consult Huck	Consult Huck	Consult Huck	Consult Huck	Consult Huck	Consult Huck	Consult Huck
MHF	P8	DT	16	50	MHFP8-DT16-50	16.0	Consult Huck	Consult Huck	Consult Huck	Consult Huck	Consult Huck	Consult Huck	Consult Huck	Consult Huck	Consult Huck	Consult Huck
MHF	P8	DT	16	55	MHFP8-DT16-55	16.0	Consult Huck	Consult Huck	Consult Huck	Consult Huck	Consult Huck	Consult Huck	Consult Huck	Consult Huck	Consult Huck	Consult Huck
MHF	P8	DT	16	60	MHFP8-DT16-60	16.0	Consult Huck	Consult Huck	Consult Huck	Consult Huck	Consult Huck	Consult Huck	Consult Huck	Consult Huck	Consult Huck	Consult Huck
MHF	P8	DT	16	65	MHFP8-DT16-65	16.0	Consult Huck	Consult Huck	Consult Huck	Consult Huck	Consult Huck	Consult Huck	Consult Huck	Consult Huck	Consult Huck	Consult Huck
MHF	P8	DT	16	70	MHFP8-DT16-70	16.0	Consult Huck	Consult Huck	Consult Huck	Consult Huck	Consult Huck	Consult Huck	Consult Huck	Consult Huck	Consult Huck	Consult Huck
MHF	P8	DT	16	75	MHFP8-DT16-75	16.0	Consult Huck	Consult Huck	Consult Huck	Consult Huck	Consult Huck	Consult Huck	Consult Huck	Consult Huck	Consult Huck	Consult Huck
MHF	P8	DT	16	80	MHFP8-DT16-80	16.0	Consult Huck	Consult Huck	Consult Huck	Consult Huck	Consult Huck	Consult Huck	Consult Huck	Consult Huck	Consult Huck	Consult Huck
MHF	P8	DT	16	85	MHFP8-DT16-85	16.0	Consult Huck	Consult Huck	Consult Huck	Consult Huck	Consult Huck	Consult Huck	Consult Huck	Consult Huck	Consult Huck	Consult Huck
MHF	P8	DT	16	90	MHFP8-DT16-90	16.0	Consult Huck	Consult Huck	Consult Huck	Consult Huck	Consult Huck	Consult Huck	Consult Huck	Consult Huck	Consult Huck	Consult Huck

HUCK® INTERACTIVE CD ROM : STRENGTHS & INSTALLED DIMENSIONS

HUCK-FIT

Unless stated all values are minimum

Part Number	SHEAR		TENSILE - Bare		TENSILE - PLATED		TENSILE - BRIGHT DIP		CLAMP		TYPICAL SHEAR		TYPICAL TENSILE - PLATED		Pin Retention		TYPICAL Pin Retention		TYPICAL CLAMP		V Nominal	W Nominal	R Max	S Max	T Min	U Max	Collar Type
	Newton's	kN	Newton's	kN	Newton's	kN	Newton's	kN	Newton's	kN	Newton's	kN	Newton's	kN	Newton's	kN	Newton's	kN	Newton's	kN	mm	mm	mm	mm	mm	mm	
MHFF-DT12-10	70059	70.1	92701	92.7	87719	87.7			64989	65	0									0.0	0	0.6	10.6	13.8	18.3	Hex Collar	
MHFF-DT12-15	70059	70.1	92701	92.7	87719	87.7			64989	65	0									0.0	0	0.6	10.6	13.8	18.3	Hex Collar	
MHFF-DT12-20	70059	70.1	92701	92.7	87719	87.7			64989	65	0									0.0	0	0.6	10.6	13.8	18.3	Hex Collar	
MHFF-DT12-25	70059	70.1	92701	92.7	87719	87.7			64989	65	0									0.0	0	0.6	10.6	13.8	18.3	Hex Collar	
MHFF-DT12-30	70059	70.1	92701	92.7	87719	87.7			64989	65	0									0.0	0	0.6	10.6	13.8	18.3	Hex Collar	
MHFF-DT12-35	70059	70.1	92701	92.7	87719	87.7			64989	65	0									0.0	0	0.6	10.6	13.8	18.3	Hex Collar	
MHFF-DT12-40	70059	70.1	92701	92.7	87719	87.7			64989	65	0									0.0	0	0.6	10.6	13.8	18.3	Hex Collar	
MHFF-DT12-45	70059	70.1	92701	92.7	87719	87.7			64989	65	0									0.0	0	0.6	10.6	13.8	18.3	Hex Collar	
MHFF-DT12-50	70059	70.1	92701	92.7	87719	87.7			64989	65	0									0.0	0	0.6	10.6	13.8	18.3	Hex Collar	
MHFF-DT12-55	70059	70.1	92701	92.7	87719	87.7			64989	65	0									0.0	0	0.6	10.6	13.8	18.3	Hex Collar	
MHFF-DT12-60	70059	70.1	92701	92.7	87719	87.7			64989	65	0									0.0	0	0.6	10.6	13.8	18.3	Hex Collar	
MHFF-DT12-65	70059	70.1	92701	92.7	87719	87.7			64989	65	0									0.0	0	0.6	10.6	13.8	18.3	Hex Collar	
MHFF-DT12-70	70059	70.1	92701	92.7	87719	87.7			64989	65	0									0.0	0	0.6	10.6	13.8	18.3	Hex Collar	
MHFF-DT12-75	70059	70.1	92701	92.7	87719	87.7			64989	65	0									0.0	0	0.6	10.6	13.8	18.3	Hex Collar	
MHFF-DT16-10	125974	126	171924	171.9	163027	163			116010	116	0									0.0	0	0.6	10.6	17.7	24.1	Hex Collar	
MHFF-DT16-15	125974	126	171924	171.9	163027	163			116010	116	0									0.0	0	0.6	10.6	17.7	24.1	Hex Collar	
MHFF-DT16-20	125974	126	171924	171.9	163027	163			116010	116	0									0.0	0	0.6	10.6	17.7	24.1	Hex Collar	
MHFF-DT16-25	125974	126	171924	171.9	163027	163			116010	116	0									0.0	0	0.6	10.6	17.7	24.1	Hex Collar	
MHFF-DT16-30	125974	126	171924	171.9	163027	163			116010	116	0									0.0	0	0.6	10.6	17.7	24.1	Hex Collar	
MHFF-DT16-35	125974	126	171924	171.9	163027	163			116010	116	0									0.0	0	0.6	10.6	17.7	24.1	Hex Collar	
MHFF-DT16-40	125974	126	171924	171.9	163027	163			116010	116	0									0.0	0	0.6	10.6	17.7	24.1	Hex Collar	
MHFF-DT16-45	125974	126	171924	171.9	163027	163			116010	116	0									0.0	0	0.6	10.6	17.7	24.1	Hex Collar	
MHFF-DT16-50	125974	126	171924	171.9	163027	163			116010	116	0									0.0	0	0.6	10.6	17.7	24.1	Hex Collar	
MHFF-DT16-55	125974	126	171924	171.9	163027	163			116010	116	0									0.0	0	0.6	10.6	17.7	24.1	Hex Collar	
MHFF-DT16-60	125974	126	171924	171.9	163027	163			116010	116	0									0.0	0	0.6	10.6	17.7	24.1	Hex Collar	
MHFF-DT16-65	125974	126	171924	171.9	163027	163			116010	116	0									0.0	0	0.6	10.6	17.7	24.1	Hex Collar	
MHFF-DT16-70	125974	126	171924	171.9	163027	163			116010	116	0									0.0	0	0.6	10.6	17.7	24.1	Hex Collar	
MHFF-DT16-75	125974	126	171924	171.9	163027	163			116010	116	0									0.0	0	0.6	10.6	17.7	24.1	Hex Collar	
MHFF-DT16-80	125974	126	171924	171.9	163027	163			116010	116	0									0.0	0	0.6	10.6	17.7	24.1	Hex Collar	
MHFF-DT16-85	125974	126	171924	171.9	163027	163			116010	116	0									0.0	0	0.6	10.6	17.7	24.1	Hex Collar	
MHFF-DT16-90	125974	126	171924	171.9	163027	163			116010	116	0									0.0	0	0.6	10.6	17.7	24.1	Hex Collar	
MHFF-DT20-10	196967	197	255017	255	255017	255			181043	181	0									0.0	0.0	0.6	10.6	21.2	20.3	Hex Collar	
MHFF-DT20-15	196967	197	255017	255	255017	255			181043	181	0									0.0	0.0	0.6	10.6	21.2	20.3	Hex Collar	
MHFF-DT20-20	196967	197	255017	255	255017	255			181043	181	0									0.0	0.0	0.6	10.6	21.2	20.3	Hex Collar	
MHFF-DT20-25	196967	197	255017	255	255017	255			181043	181	0									0.0	0.0	0.6	10.6	21.2	20.3	Hex Collar	
MHFF-DT20-30	196967	197	255017	255	255017	255			181043	181	0									0.0	0.0	0.6	10.6	21.2	20.3	Hex Collar	
MHFF-DT20-35	196967	197	255017	255	255017	255			181043	181	0									0.0	0.0	0.6	10.6	21.2	20.3	Hex Collar	
MHFF-DT20-40	196967	197	255017	255	255017	255			181043	181	0									0.0	0.0	0.6	10.6	21.2	20.3	Hex Collar	
MHFF-DT20-45	196967	197	255017	255	255017	255			181043	181	0									0.0	0.0	0.6	10.6	21.2	20.3	Hex Collar	
MHFF-DT20-50	196967	197	255017	255	255017	255			181043	181	0									0.0	0.0	0.6	10.6	21.2	20.3	Hex Collar	
MHFF-DT20-55	196967	197	255017	255	255017	255			181043	181	0									0.0	0.0	0.6	10.6	21.2	20.3	Hex Collar	
MHFF-DT20-60	196967	197	255017	255	255017	255			181043	181	0									0.0	0.0	0.6	10.6	21.2	20.3	Hex Collar	
MHFF-DT20-65	196967	197	255017	255	255017	255			181043	181	0									0.0	0.0	0.6	10.6	21.2	20.3	Hex Collar	
MHFF-DT20-70	196967	197	255017	255	255017	255			181043	181	0									0.0	0.0	0.6	10.6	21.2	20.3	Hex Collar	
MHFF-DT20-75	196967	197	255017	255	255017	255			181043	181	0									0.0	0.0	0.6	10.6	21.2	20.3	Hex Collar	
MHFF-DT20-80	196967	197	255017	255	255017	255			181043	181	0									0.0	0.0	0.6	10.6	21.2	20.3	Hex Collar	
MHFF-DT20-85	196967	197	255017	255	255017	255			181043	181	0									0.0	0.0	0.6	10.6	21.2	20.3	Hex Collar	
MHFF-DT20-90	196967	197	255017	255	255017	255			181043	181	0									0.0	0.0	0.6	10.6	21.2	20.3	Hex Collar	
MHFF-DT20-95	196967	197	255017	255	255017	255			181043	181	0									0.0	0.0	0.6	10.6	21.2	20.3	Hex Collar	
MHFFP8-DT14-10	95948	95.9	126107	126.1	120013	120			87986	88	0									0.0	0.0	0.6	10.6	15.9	21.9	Hex Collar	
MHFFP8-DT14-15	95948	95.9	126107	126.1	120013	120			87986	88	0									0.0	0.0	0.6	10.6	15.9	21.9	Hex Collar	

HUCK® INTERACTIVE CD ROM : STRENGTHS & INSTALLED DIMENSIONS (CONTINUED)

HUCK-FIT

Unless stated all values are minimum

Part Number	SHEAR		TENSILE - Bare		TENSILE - PLATED		TENSILE - BRIGHT DIP		CLAMP		TYPICAL SHEAR		TYPICAL TENSILE - PLATED		Pin Retention		TYPICAL Pin Retention		TYPICAL CLAMP		V Nominal	W Nominal	R Max	S Max	T Min	U Max	Collar Type
	Newtons	kN	Newtons	kN	Newtons	kN	Newtons	kN	Newtons	kN	Newtons	kN	Newtons	kN	Newtons	kN	Newtons	kN	Newtons	kN	mm	mm	mm	mm	mm	mm	
MHFP8-DT14-20	95948	95.9	126107	126.1	120013	120				87986	88	0								0.0	0.0	0.6	10.6	15.9	21.9	Hex Collar	
MHFP8-DT14-25	95948	95.9	126107	126.1	120013	120				87986	88	0								0.0	0.0	0.6	10.6	15.9	21.9	Hex Collar	
MHFP8-DT14-30	95948	95.9	126107	126.1	120013	120				87986	88	0								0.0	0.0	0.6	10.6	15.9	21.9	Hex Collar	
MHFP8-DT14-35	95948	95.9	126107	126.1	120013	120				87986	88	0								0.0	0.0	0.6	10.6	15.9	21.9	Hex Collar	
MHFP8-DT14-40	95948	95.9	126107	126.1	120013	120				87986	88	0								0.0	0.0	0.6	10.6	15.9	21.9	Hex Collar	
MHFP8-DT14-45	95948	95.9	126107	126.1	120013	120				87986	88	0								0.0	0.0	0.6	10.6	15.9	21.9	Hex Collar	
MHFP8-DT14-50	95948	95.9	126107	126.1	120013	120				87986	88	0								0.0	0.0	0.6	10.6	15.9	21.9	Hex Collar	
MHFP8-DT14-55	95948	95.9	126107	126.1	120013	120				87986	88	0								0.0	0.0	0.6	10.6	15.9	21.9	Hex Collar	
MHFP8-DT14-60	95948	95.9	126107	126.1	120013	120				87986	88	0								0.0	0.0	0.6	10.6	15.9	21.9	Hex Collar	
MHFP8-DT14-65	95948	95.9	126107	126.1	120013	120				87986	88	0								0.0	0.0	0.6	10.6	15.9	21.9	Hex Collar	
MHFP8-DT14-70	95948	95.9	126107	126.1	120013	120				87986	88	0								0.0	0.0	0.6	10.6	15.9	21.9	Hex Collar	
MHFP8-DT14-75	95948	95.9	126107	126.1	120013	120				87986	88	0								0.0	0.0	0.6	10.6	15.9	21.9	Hex Collar	
MHFP8-DT16-10	125974	126	171924	171.9	163027	163				116010	116	0								0.0	0.0	0.6	10.6	17.7	24.1	Hex Collar	
MHFP8-DT16-15	125974	126	171924	171.9	163027	163				116010	116	0								0.0	0.0	0.6	10.6	17.7	24.1	Hex Collar	
MHFP8-DT16-20	125974	126	171924	171.9	163027	163				116010	116	0								0.0	0.0	0.6	10.6	17.7	24.1	Hex Collar	
MHFP8-DT16-25	125974	126	171924	171.9	163027	163				116010	116	0								0.0	0.0	0.6	10.6	17.7	24.1	Hex Collar	
MHFP8-DT16-30	125974	126	171924	171.9	163027	163				116010	116	0								0.0	0.0	0.6	10.6	17.7	24.1	Hex Collar	
MHFP8-DT16-35	125974	126	171924	171.9	163027	163				116010	116	0								0.0	0.0	0.6	10.6	17.7	24.1	Hex Collar	
MHFP8-DT16-40	125974	126	171924	171.9	163027	163				116010	116	0								0.0	0.0	0.6	10.6	17.7	24.1	Hex Collar	
MHFP8-DT16-45	125974	126	171924	171.9	163027	163				116010	116	0								0.0	0.0	0.6	10.6	17.7	24.1	Hex Collar	
MHFP8-DT16-50	125974	126	171924	171.9	163027	163				116010	116	0								0.0	0.0	0.6	10.6	17.7	24.1	Hex Collar	
MHFP8-DT16-55	125974	126	171924	171.9	163027	163				116010	116	0								0.0	0.0	0.6	10.6	17.7	24.1	Hex Collar	
MHFP8-DT16-60	125974	126	171924	171.9	163027	163				116010	116	0								0.0	0.0	0.6	10.6	17.7	24.1	Hex Collar	
MHFP8-DT16-65	125974	126	171924	171.9	163027	163				116010	116	0								0.0	0.0	0.6	10.6	17.7	24.1	Hex Collar	
MHFP8-DT16-70	125974	126	171924	171.9	163027	163				116010	116	0								0.0	0.0	0.6	10.6	17.7	24.1	Hex Collar	
MHFP8-DT16-75	125974	126	171924	171.9	163027	163				116010	116	0								0.0	0.0	0.6	10.6	17.7	24.1	Hex Collar	
MHFP8-DT16-80	125974	126	171924	171.9	163027	163				116010	116	0								0.0	0.0	0.6	10.6	17.7	24.1	Hex Collar	
MHFP8-DT16-85	125974	126	171924	171.9	163027	163				116010	116	0								0.0	0.0	0.6	10.6	17.7	24.1	Hex Collar	
MHFP8-DT16-90	125974	126	171924	171.9	163027	163				116010	116	0								0.0	0.0	0.6	10.6	17.7	24.1	Hex Collar	

HUCK® INTERACTIVE CD ROM : COLLARS

HUCK-FIT

FAM	TYPE	Mat	Dia	Part Number	K Max mm	L Max mm	M Nom mm	N Min mm
MHS	CF	R	12	MHSCF-R12	26.3	19.1		
MHS	CF	R	14	MHSCF-R14	30.5	22.1		
MHS	CF	R	16	MHSCF-R16	34.8	24.0		
MHS	CF	R	20	MHSCF-R20	43.1	29.4		
MHS	H	R	12	MHSH-R12	23.2	21.4	23.0	
MHS	H	R	14	MHSH-R14	25.8	26.2	29.1	
MHS	H	R	16	MHSH-R16	29.2	29.3	31.8	
MHS	H	R	20	MHSH-R20	34.9	34.2	37.7	
MH	CH	R	12	MHCH-R12	23.2	21.4	23.0	
MH	CH	R	14	MHCH-R14	25.8	26.2	29.1	
MH	CH	R	16	MHCH-R16	29.2	29.3	31.8	
MH	CH	R	20	MHCH-R20	34.9	34.2	37.7	

HUCK® INTERACTIVE CD ROM : HEADSTYLES

ALL PRODUCTS

Name	Family	Part	Type	Description
C120L	C120L	Collar	2	Standard
C120L	C120L	Collar	3	Flanged
C120L	C120L	Collar	8	Low Profile
C120L	C120L	Pin	B	Brazier
C120L	C120L	Pin	T	Truss
C120L	C120L	Pin	90	Countersunk
C6L	C6L	Collar	2	Standard
C6L	C6L	Collar	3	Flanged
C6L	C6L	Collar	8	Low Profile
C6L	C6L	Pin	B	Brazier
C6L	C6L	Pin	T	Truss
C6L	C6L	Pin	90	Countersunk
Magna-Grip	MGP	Pin	B	Button
Magna-Grip	MGP	Pin	T	Truss
Magna-Grip	MGP	Pin	30	Broad Truss
Magna-Grip	MGP	Pin	90	90 Degree Countersunk
Magna-Grip	MGP	Pin	98T	Rivet
Magna-Grip	MG	Collar	C	Standard Flange
Magna-Grip	MG	Collar	CS	Medium Flange
Magna-Grip	MG	Collar	CW	Wide Flange
Hucktainer	HLP	Pin	P	Standard Low Profile
Hucktainer	HLP	Pin	E	Encapsulated
Hucktainer	HLP	Pin	M	Medium sized encapsulated
Hucktainer	HLP	Collar	S	Wide bearing sleeve
Hucktainer	HLP	Collar	SM	Medium bearing sleeve
Hucktainer	HLP	Collar	SC	Clearance sleeve
Hucktainer	HLP	Collar	SGC	Short grip clearance sleeve
Hucktainer	HLP	Collar	SGM	Short grip medium sleeve
Hucktainer	HLP	Collar	SG	Short grip wide bearing sleeve
C50L	C50L	Pin	R	Round
C50L	C50L	Pin	T	Truss
C50L	C50L	Pin	90	90 Degree Countersunk
C50L	C50L	Collar	LC	Standard
C50L	C50L	Collar	3LC	Flanged

Name	Family	Part	Type	Description
C50L	C50L	Collar	8LC	Low Profile
HP8	HP8	Pin	F	Flanged
HP8	HP	Collar	BF	Flanged
Huck-Fit	MHF	Pin	F	Flanged
Huck-Fit	MHF	Pin	P8	Freightliner
Huck-Fit	MH	Collar	CH	Threaded Hex Flange
Huck-Spin	MHS	Collar	H	Threaded Hex Flange
Huck-Spin	MHS	Collar	CF	Round Flange
Huck-Spin	MHS	Pin	F	Hexagonal
Huck-Spin	MHS	Pin	PF	Round
Small diameter Huck-Spin	HS2	Pin	B	Brazied
Small diameter Huck-Spin	HS5	Pin	B	Brazied
Small diameter Huck-Spin	HS8	Pin	B	Brazied
Small diameter Huck-Spin	HS2	Pin	90	90 Degree Countersunk
Small diameter Huck-Spin	HS5	Pin	90	90 Degree Countersunk
Small diameter Huck-Spin	HS2	Collar	F	Flanged
Small diameter Huck-Spin	HS5	Collar	F	Flanged
Small diameter Huck-Spin	HS8	Collar	F	Flanged
Magna-Lok	MGL	Blind	P	Protunding
Magna-Lok	MGL	Blind	T	Truss
Magna-Lok	MGL	Blind	100	100 Degree Countersunk
Magna-Bulb	MB	Blind	P	Protunding
Auto-Bulb	AB	Blind	P	Protunding
Magna-Tite	MT	Blind	P	Protunding
Magna-Tite	MT	Blind	V	100 Degree Oval
Magna-Tite	MT	Blind	S	Shavable
Magna-Tite	MT	Blind	LP	Low Profile
Huck-Lok	HKL	Blind	P	Protunding
FloorTight	PMF	Blind		Installation in Plywood
FloorTight	PMF	Blind		Installation in Plymetal

*BOM does not have a headstyle

HUCK® INTERACTIVE CD ROM : MATERIALS & COATINGS

ALL PRODUCTS

Family	Part	Material Code	Material	Standard Coating	Standard Coating Code	Tab-Lok Available
Auto-Bulb	Pin	R	Medium Carbon Steel	"Zinc plate, gold chromate"		
Auto-Bulb	Sleeve	R	Low Carbon Steel	"Zinc plate, gold chromate"		
BOM	Pin - 4.8mm to 7.9mm diameter	R	Carbon Steel	Bare		
BOM	Pin - 9.5mm to 19.1mm diameter	R	Alloy Steel	Bare		
BOM	Sleeve	R	Carbon Steel	Zinc plating per spec ASTM B633 or ASTM B695. Meets specification of QQ-Z-235 and MIL-C-81562		
C120L	Collar	R/2R	Low Carbon Steel	"Zinc plate, clear chromate"	G	
C120L	Pin	R	Carbon Steel/Carbon Boron Steel	"Zinc plate, clear chromate"	G	
C50L	Collar	2CU	Stainless Steel	Pasivated	-	Yes
C50L	Collar	2R	Low Carbon Steel	"Zinc plate, clear chromate"	G	Yes
C50L	Collar	F	6061 Aged Aluminium Alloy	Pasivated	-	Yes
C50L	Collar	I	6061 Aluminium Alloy	Pasivated	-	Yes
C50L	Pin	BR	Carbon Steel/Carbon Boron Steel	Bare	-	
C50L	Pin	C	2024 Aluminium Alloy	Pasivated	-	
C50L	Pin	F	6061 Aluminium Alloy	Pasivated	-	
C50L	Pin	U	Stainless Steel	Pasivated	-	
C6L	Collar	2CU	Stainless Steel	"Zinc plate, clear chromate"	G	
C6L	Collar	F	5062 Aluminium Alloy	"Zinc plate, clear chromate"	G	
C6L	Collar	I	6061 Aluminium Alloy	"Zinc plate, clear chromate"	G	
C6L	Collar	R/2R	Low Carbon Steel	"Zinc plate, clear chromate"	G	
C6L	Pin	C	Aluminium Alloy	"Zinc plate, clear chromate"	G	
C6L	Pin	F	Aluminium Alloy	"Zinc plate, clear chromate"	G	
C6L	Pin	R	Carbon Steel/Carbon Boron Steel	"Zinc plate, clear chromate"	G	
C6L	Pin	U	Stainless Steel	"Zinc plate, clear chromate"	G	
FloorTight	Pin	R	Steel	Black		
FloorTight	Sleeve	R	Steel	Zinc electroplate with gold chromate		
HP8	Collar	R	Low Carbon Steel	"Zinc plate, clear chromate"	G	Yes
HP8	Pin	DT	Medium Carbon Steel	Bare	-	
Huck-Fit	Collar		Low Carbon Steel	"Zinc plate, gold chromate"	U	Yes
Huck-Fit	Pin	DT	Carbon Steel/Carbon Boron Steel	Bare	-	
HuckLok	Pin	R	Medium Carbon Steel	"Zinc plate, clear chromate"		
HuckLok	Sleeve	R	Low Carbon Steel	"Zinc plate, clear chromate"		
Huck-Spin	Collar	R	Low Carbon Steel	"Zinc plate, gold chromate"	U	
Huck-Spin	Pin	DT	Carbon Steel/Carbon Boron Steel	Consult Huck	-	
Small Diameter Huck-Spin	Collar	R	Low Carbon Steel	Consult Huck		
Small Diameter Huck-Spin	Pin	R	Low Carbon Steel	Consult Huck		
Small Diameter Huck-Spin	Pin	DT	Carbon Steel/Carbon Boron Steel	Consult Huck		
Hucktainer Plus	Collar	R	Low Carbon Steel	"Zinc plate, gold chromate"	U	
Hucktainer Plus	Pin	R	Low Carbon Steel	"Zinc plate, clear chromate"	G	
Magna-Bulb	Pin	R	Medium Carbon Steel	"Zinc plate, gold chromate"		
Magna-Bulb	Sleeve	R	Low Carbon Steel	"Zinc plate, gold chromate"		
Magna-Grip	Collar	F	7075-T6 Aluminium Alloy		-	Yes
Magna-Grip	Collar	R	Low Carbon Steel	"Zinc plate, clear chromate"	G	Yes
Magna-Grip	Pin	E	6061 Aluminium Alloy		-	
Magna-Grip	Pin	R	Carbon Steel	"Zinc plate, clear chromate"	G	
Magna-Lok	Pin	B	7075 Aluminium Alloy	Gold chromate		
Magna-Lok	Pin	R	Medium Carbon Steel	"Zinc plate, gold chromate"		
Magna-Lok	Pin	U	Stainless Steel	Pasivated		
Magna-Lok	Sleeve	B	5056 Aluminium Alloy	Clear chromate		
Magna-Lok	Sleeve	R	Low Carbon Steel	"Zinc plate, clear chromate"		
Magna-Lok	Sleeve	U	Stainless Steel	Pasivated		
Magna-Tite	Pin	B	Aluminum Alloy	Consult Huck		
Magna-Tite	Sleeve	B	Aluminum Alloy	Consult Huck		

HUCK-FIT

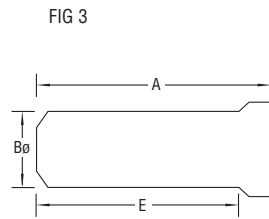
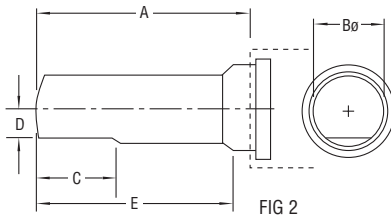
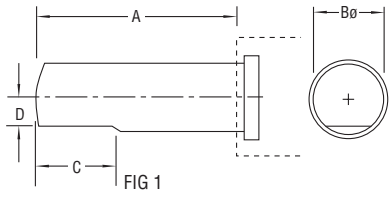

HUCK® INTERACTIVE CD ROM : TOOLING MATRIX

HUCK-FIT

Dia.	Nose Assembly Options		Nose Assembly Dimensions					Hydraulic Tool Options				Powerig Options					Hose Set Options		
	FOCUS	Non-FOCUS			ø				FOCUS		Non-FOCUS		FOCUS		Non-FOCUS		FOCUS	Non-FOCUS	
	1	2	Fig.	A mm	B mm	C mm	D mm	E mm	1	2	3	4	1	2	3	4	5	1	2
12		99-5406	1	104.0	44.5	55.5	20.7	-	2620-PT		2620		HK432-2 Series	HK3413 Series	HP74 Series		HK4245 Series	HS - 10 - MCE (Length 10 Metres)	*
		99-6400	3	135.5	43.0	-	-	110.5			HPT25H	HPT25RH	HK432-2 Series	HK3413 Series	HP74 Series		HK4245 Series	HS - 10 - MCE (Length 10 Metres)	*
14		99-5408	2	97.5	44.5	76.0	19.7	83.5	2628		2624		HK432-2 Series	HK3413 Series	HP74 Series	HP116 Series	HK4245 Series	HS - 10 - MCE (Length 10 Metres)	*
		99-6402	3	169.0	49.5	-	-	140.5			HPT35H	HPT35RH	HK432-2 Series	HK3413 Series	HP74 Series	HP116 Series	HK4245 Series	HS - 10 - MCE (Length 10 Metres)	*
16		99-5301	2	106.5	53.0	60.0	22.9	98.5	2628				HK432-2 Series	HK3413 Series	HP74 Series	HP116 Series	HK4245 Series	HS - 10 - MCE (Length 10 Metres)	*
		99-6302	3	172.5	50.0	-	-	145.5			HPT35H	HPT35RH	HK432-2 Series	HK3413 Series			HK4245 Series	HS - 10 - MCE (Length 10 Metres)	*
20		99-5414	2	69.0	69.9	58.5	31.5	-			2630		HK432-2 Series	HK3413 Series	HP74 Series	HP116 Series	HK4245 Series	HS - 10 - MCE (Length 10 Metres)	*
		99-6405	3	194.0	55.5	-	-	162.0			HPT57H	HPT57RH	HK432-2 Series	HK3413 Series			HK4245 Series	HS - 10 - MCE (Length 10 Metres)	*

*Contact Huck for availability of other Hose Set lengths.